

1.5A Step-Up Current Regulator for Flash LEDs

General Description

The AAT1277 is a high-efficiency, high-current boost converter capable of 1.5A typical output current. It is an ideal power solution for LED photo flash applications in all single cell Li-ion powered products.

The AAT1277 maintains output current regulation by switching the internal high-side and low-side switch transistors. The transistor switches are pulse-width modulated at a fixed frequency of 2MHz. The high switching frequency allows the use of a small inductor and output capacitor, making the AAT1277 ideally suited for small battery-powered applications.

Three simple logic control inputs enable and disable flash and movie mode operation of the AAT1277. Movie-mode and Flash-mode current levels are independently fixed by two separate resistors. For Flash mode, a default timer can be used either to terminate a flash event or as a safety feature. Also included is a Flash Inhibit pin which reduces the flash current to movie-mode levels during high battery demand. One or two LEDs can be connected to the AAT1277; in the case of two LEDs the output current is matched between each diode.

The AAT1277 contains a thermal management system to protect the device in the event of an output short-circuit condition. Built-in circuitry prevents excessive inrush current during start-up. The shutdown feature reduces quiescent current to less than 1.0µA.

The AAT1277 is available in a 18 ball 1.5mm x 2.4mm CSP package.

Typical Application

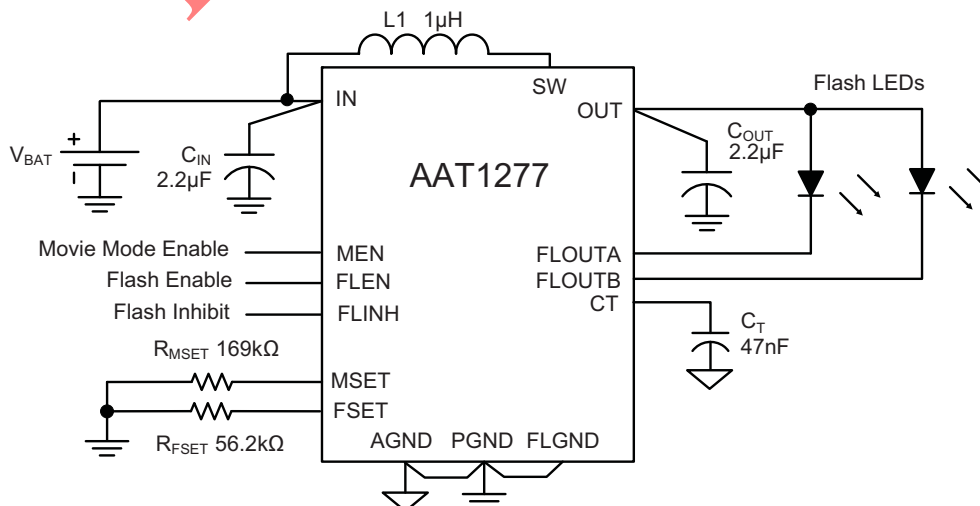

Features

- V_{IN} Range: 2.7V to 5.5V
- Dual Channel Output
- Up to 1.5A Regulated Output Current (750mA per channel)
- Up to 85% Efficiency with Small Inductor (1µH)
- 2 MHz Switching Frequency
- Separate Flash/Movie Mode Enable
- Separate Flash Inhibit
- User-Programmable Safety Timer
- Two Resistors Set Flash and Movie Mode Current Independently
- True Load Disconnect
- Bypass Mode Input Current Limit 1.9A (typ.)
- Over-Voltage (Open LED, Open Circuit) Protection
- Short Circuit Protection
- Over-Temperature Protection
- Shutdown Current < 1.0µA
- 18 Ball 1.5mm x 2.4mm CSP Package
- -40°C to +85°C Operating Temperature Range

Applications

- Cellphones/Smartphones
- LED Photo Flash/Torch
- Mobile Handsets

1.5A Step-Up Current Regulator for Flash LEDs**Pin Descriptions**

| Ball # | Symbol | Function |
|------------|--------|--|
| A1 | CT | Flash timer control input. Connect a capacitor between CT and AGND to set maximum duration of the flash pulse. A 47nF ceramic capacitor sets the flash timer to 375ms. To disable the flash timer, connect CT to AGND. |
| A2 | MEN | Movie mode enable pin. A low to high transition on the MEN pin initiates movie mode current level set by MSET resistor. MEN is an active high control input with a internal 200kΩ resistor to AGND. |
| A3 | FLEN | Flash enable pin. A low-to-high transition on the FLEN pin initiates a flash pulse and starts the flash timer. FLEN is an active high control input with a internal 200kΩ resistor to AGND. |
| A4 | AGND | Analog ground pin. Connect AGND to PGND and FLGND at a single point as close to AAT1277 as possible. |
| A5 | IN | Power input. Connect IN to the input power supply voltage. Connect a 2.2μF or larger ceramic capacitor from IN to PGND as close as possible to AAT1277. |
| A6, B3, B4 | PGND | Power ground pin. Connect PGND to AGND and FLGND at a single point as close to AAT1277 as possible. |
| B1 | FSET | Flash mode current setting input. A 56.2kΩ resistor from FSET to AGND sets the maximum flash current available at FLOUTA and FLOUTB up to 1.5A total. Each FLOUTA and FLOUTB channel will conduct 50% of the maximum programmed current |
| B2, C2 | FLGND | Flash ground pin. Connect FLGND to PGND and AGND at a single point as close to AAT1277 as possible |
| B5, B6 | SW | Boost converter switching node. Connect a 1μH inductor between SW and IN. |
| C1 | FLOUTA | Flash Output A. Connect cathode of Flash LEDA to FLOUTA. For a single flash LED, connect FLOUTA and FLOUTB together. For two flash LEDs, each output will conduct 50% of the total flash output current. |
| C3 | FLOUTB | Flash Output B. Connect cathode of Flash LEDB to FLOUTB. For a single flash LED, connect FLOUTB & FLOUTA together. For two flash LEDs, each output will conduct 50% of the total flash output current. |
| C4 | FLINH | Flash inhibit pin. FLINH is an active high control input with an internal 200kΩ resistor to AGND. A low-to-high transition on the FLINH pin reduces FLOUTA and FLOUTB output currents to the preset movie-mode current level for the duration of FLINH. Strobing the FLINH pin low to high does not reset the flash timer. |
| C5 | MSET | Movie mode current setting input. A 169kΩ resistor from MSET to AGND sets the desired movie mode current available at FLOUTA and FLOUTB to 100mA total. Each FLOUTA and FLOUTB channel will conduct 50% of the programmed current. |
| C6 | OUT | Power output of the boost converter. Connect a 2.2μF or larger ceramic capacitor from OUT to PGND as close as possible to the AAT1277. Connect OUT to the anode(s) of the Flash LED(s). |

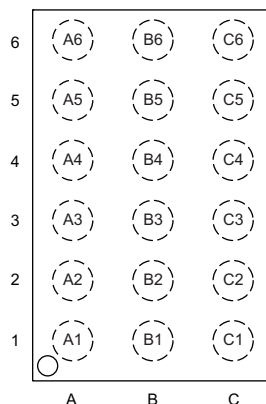
Pin Configuration**CSP Ball/Pin Layout****(Top View)**

1.5A Step-Up Current Regulator for Flash LEDs

Absolute Maximum Ratings¹

(T_A = 25°C unless otherwise noted.)

| Symbol | Description | Value | Units |
|----------------------------------|---|------------------------|-------|
| IN, SW, OUT | Maximum Rating | -0.3 to 6.0 | V |
| MEN, FLEN, FLINH, CT, MSET, FSET | Maximum Rating | V _{IN} + 0.3 | |
| FLOUTA, FLOUTB | Maximum Rating | V _{OUT} + 0.3 | |
| T _J | Junction Temperature Range | -40 to 150 | °C |
| T _A | Operating Temperature Range | -40 to 85 | |
| T _s | Storage Temperature Range | -65 to 150 | |
| T _{LEAD} | Maximum Soldering Temperature (at leads, 10 sec.) | 300 | |

Thermal Information²

| Symbol | Description | Value | Units |
|-----------------|--|-------|-------|
| θ _{JA} | Thermal Resistance | 105.5 | °C/W |
| P _D | Maximum Power Dissipation ³ | 940 | mW |

DISCONTINUED

1. Stresses above those listed in Absolute Maximum Ratings may cause permanent damage to the device. Functional operation at conditions other than the operating conditions specified is not implied.
 2. Mounted on an FR4 board.
 3. Derate 9.4 mW above 25°C.

1.5A Step-Up Current Regulator for Flash LEDs

Electrical Characteristics¹

$V_{IN} = 3.6V$; $C_{IN} = C_{OUT} = 2.2\mu F$; $L1 = 1\mu H$; $R_{FSET} = 56.2k\Omega$; $R_{MSET} = 169k\Omega$; $T_A = -40^\circ C$ to $85^\circ C$ unless otherwise noted. Typical values are at $T_A = 25^\circ C$.

| Symbol | Description | Conditions | Min | Typ | Max | Units |
|---|--|--|------|------|------|------------|
| Power Supply | | | | | | |
| V_{IN} | Input Voltage Range | | 2.7 | | 5.5 | V |
| $V_{OUT(MAX)}$ | Maximum Output Voltage | | | | 5.5 | |
| $I_{IN(Q)}$ | V_{IN} Supply Current | $V_{FLEN} = V_{IN}$, FL Load = 1.5A | | 1.4 | | mA |
| | | $V_{FLEN} = V_{IN}$, FL Load = 0A | | 0.23 | | |
| $I_{SHDN(MAX)}$ | V_{IN} Shutdown Current | $V_{MEN} = V_{FLEN} = V_{FLINH} = GND$ | | | 1 | μA |
| $I_{FL(TOTAL)}$ | Total Output Current, Flash Mode | $I_{FLOUTA} + I_{FLOUTB}$ | 1.2 | 1.5 | | A |
| I_{FL} | FLOUTA / FLOUTB Current Accuracy | | -5 | | 5 | % |
| $I_{FL(MATCH)}$ | FLOUTA / FLOUTB Current Matching Tolerance | | | 10 | | % |
| $I_{MM(LOAD)}$ | Total Output Current, Movie Mode | $I_{MMOUTA} + I_{MMOUTB}$ | 93 | 100 | 107 | mA |
| f_{OSC} | Oscillator Switching Frequency | $T_A = 25^\circ C$ | 1.45 | 2.0 | 2.55 | MHz |
| $t_{DEFAULT}$ | Default ON Time | $C_T = 47nF$ | | 375 | | ms |
| T_{SD} | Thermal Shutdown Threshold | | | 140 | | $^\circ C$ |
| $T_{SD(HYS)}$ | Thermal Shutdown Hysteresis | | | 15 | | |
| FLEN/ MEN/FLINH Logic Control | | | | | | |
| $V_{MEN(L)}$, $V_{FLEN(L)}$, $V_{FLINH(L)}$ | MEN, FLEN, FLINH Input Low Threshold | | | | 0.4 | V |
| $V_{MEN(H)}$, $V_{FLEN(H)}$, $V_{FLINH(H)}$ | MEN, FLEN, FLINH Input High Threshold | | 1.4 | | | V |
| $R_{IN(LOGIC)}$ | FLINH, FLEN, MEN Input Resistance to AGND | | 100 | 200 | | k Ω |
| t_{FLEN_ON} | FLEN ON Delay Time | | | 200 | | μs |
| t_{FLEN_OFF} | FLEN OFF Delay Time | | | 10 | | |
| t_{FLINH_ON} | FLINH ON Delay Time | | | 93 | | |
| t_{FLINH_OFF} | FLINH OFF Delay Time | | | 5 | | |
| Auto Disable Function² | | | | | | |
| $V_{LED(DETECT)}$ | Shorted LED Detection Voltage | $V_{IN} = 3V$, $I_{LED} = 0.795\mu A$ | 1.45 | | | V |
| $I_{LED(DETECT)}$ | Minimum LED Detection Current | $V_{IN} = 3V$ | 795 | | | μA |

1. The AAT1277 is guaranteed to meet performance specifications over the $-40^\circ C$ to $+85^\circ C$ operating temperature range and is assured by design, characterization, and correlation with statistical process controls.
2. Guaranteed by Design

Flash Mode Efficiency vs. Input Voltage

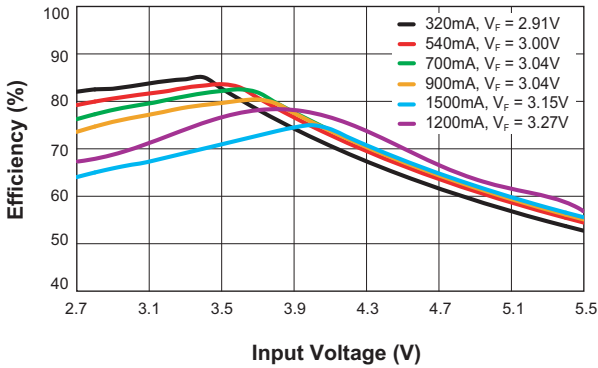

Movie Mode Efficiency vs. Input Voltage

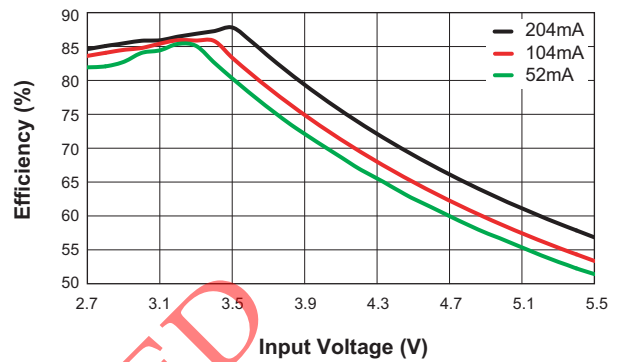

Shutdown Current vs. Input Voltage

($V_{MEN} = V_{FLEN} = V_{FLINH} = 0V$)

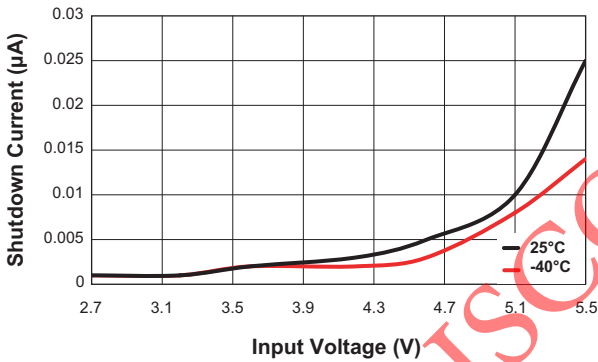

Quiescent Current vs. Input Voltage

($V_{FLEN} = V_{IN}; I_{FLOUTA} = I_{FLOUTB} = 0mA$)

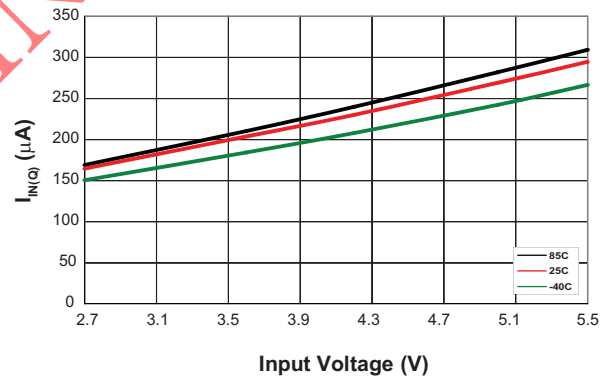

Movie Mode Current Accuracy vs. Temperature

($V_{IN} = 3.6V; I_{FLOUTA} = I_{FLOUTB} = 50mA$)

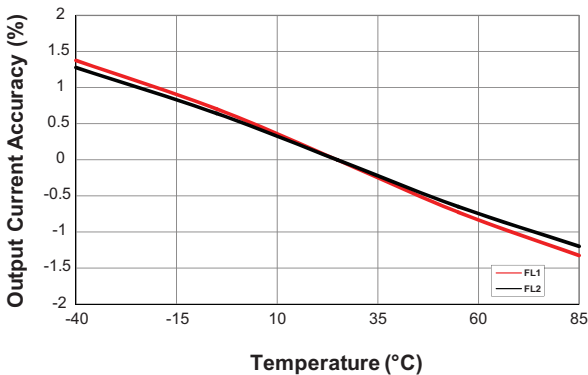

Flash and Movie Modes Current Matching vs. Temperature

($V_{IN} = 3.6V$)

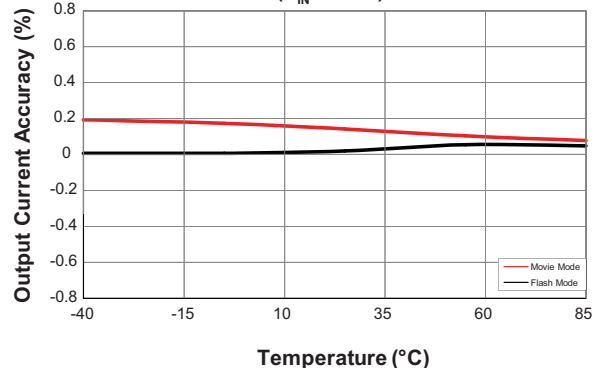

Flash LED Current Accuracy vs. Temperature

($V_{IN} = 3.6V$; $I_{FLOUTA} = I_{FLOUTB} = 750mA$)

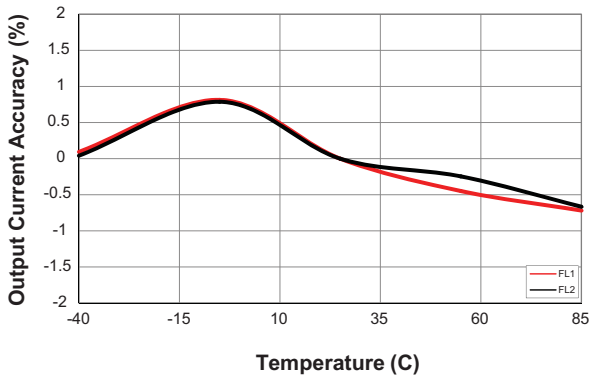

Flash ON Delay Time vs. Input Voltage

($I_{FLOUTA} = I_{FLOUTB} = 750mA$; $C_{OUT} = 2.2\mu F$; $L = 1\mu H$)

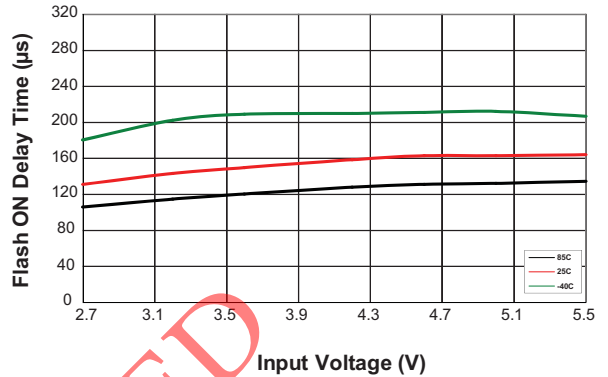

Flash ON Time vs. Input Voltage

($I_{FLOUTA} = I_{FLOUTB} = 750mA$; $C_T = 47nF$; $C_{OUT} = 2.2\mu F$; $L = 1\mu H$)

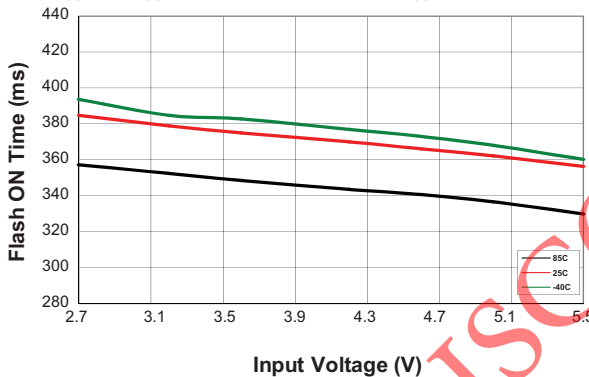

Flash Timeout Delay vs. C_T Capacitor

($I_{FLOUTA} = I_{FLOUTB} = 750mA/ch$; $V_{IN} = 3.6V$)

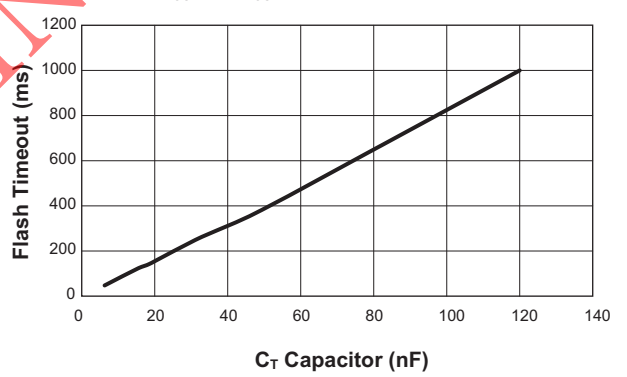

Movie Mode Current Accuracy vs. Input Voltage

($I_{FLOUTA} = I_{FLOUTB} = 50mA$; $C_{OUT} = 2.2\mu F$; $L = 1\mu H$)

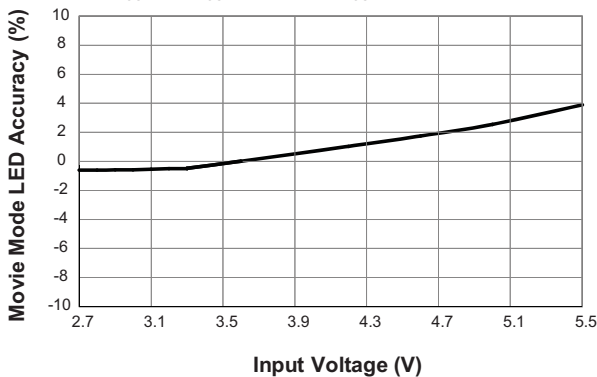

Oscillator Frequency Accuracy vs. Temperature

($V_{IN} = 3.6V$; $F_{OSC} = 2MHz$)

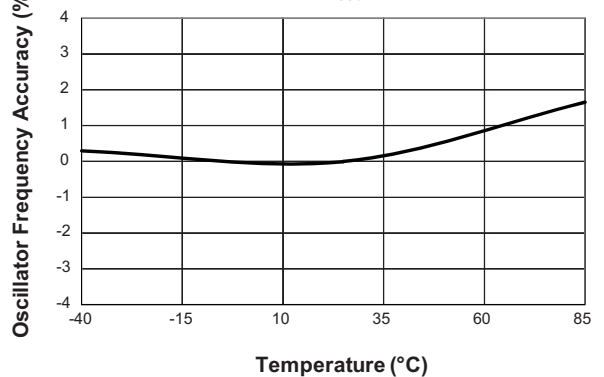

DISCONTINUED

Oscillator Frequency vs. Input Voltage

($T_A = 25^\circ\text{C}$)

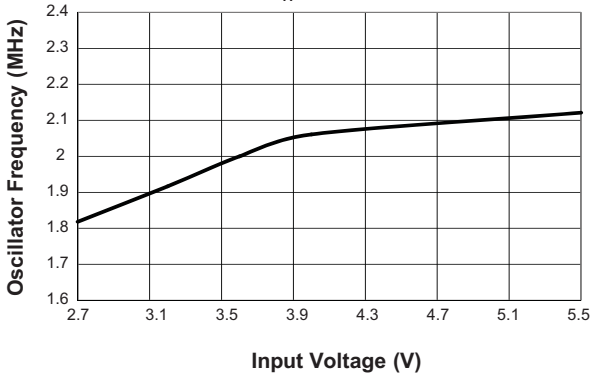

Flash Mode Output Ripple

($I_{\text{FLOUT}} = 1.5\text{A}$; $V_{\text{IN}} = 4\text{V}$; $L = 1\mu\text{H}$)

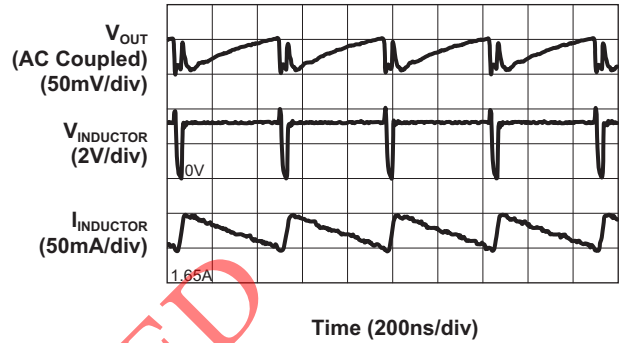

Movie Mode Line Transient

($I_{\text{FLOUT}} = 206\text{mA}$; $V_{\text{IN}} = 4.2\text{V}$ to 3.6V)

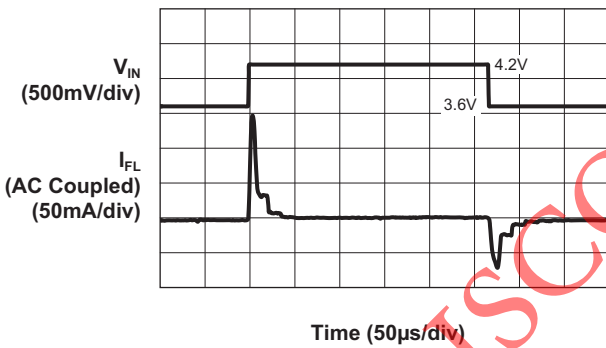

Movie Mode Turn On Characteristic

($I_{\text{FLOUTA}} = I_{\text{FLOUTB}} = 50\text{mA}$; $C_{\text{OUT}} = 2.2\mu\text{F}$; $V_{\text{IN}} = 3.6\text{V}$; $L = 1\mu\text{H}$)

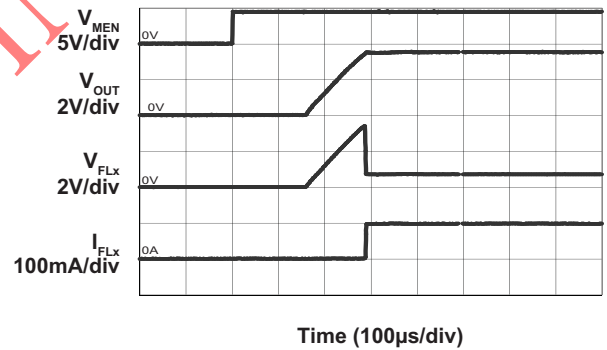

Movie Mode to Flash Turn On Characteristic

($I_{\text{FLOUTA}} = I_{\text{FLOUTB}} = 50\text{mA}$ to 750mA ; $C_{\text{OUT}} = 1.0\mu\text{F}$; $V_{\text{IN}} = 3.6\text{V}$; $L = 1\mu\text{H}$)

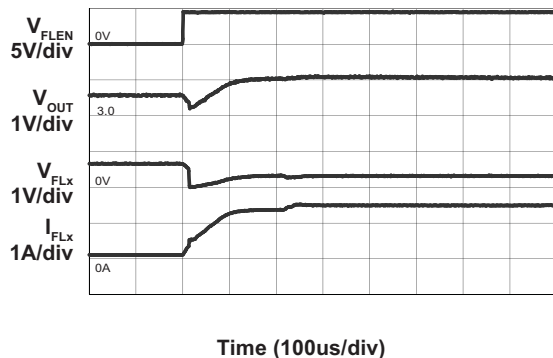

Flash Turn On Characteristic

($I_{\text{FLOUTA}} = I_{\text{FLOUTB}} = 750\text{mA}$; $C_{\text{OUT}} = 2.2\mu\text{F}$; $V_{\text{IN}} = 3.6\text{V}$; $L = 1\mu\text{H}$)

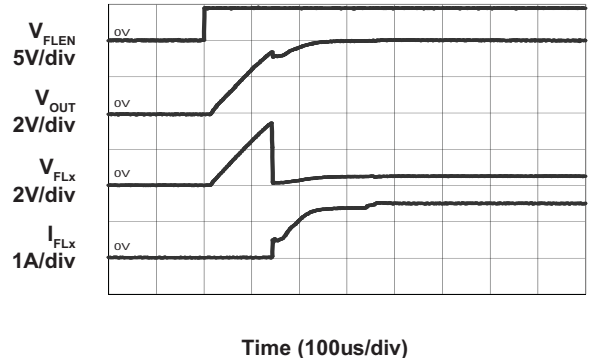

Flash Inhibit Turn On Characteristic

($I_{FLOUTA} = I_{FLOUTB} = 750\text{mA}$; $C_{OUT} = 2.2\mu\text{F}$; $V_{IN} = 3.6\text{V}$; $L = 1\mu\text{H}$)

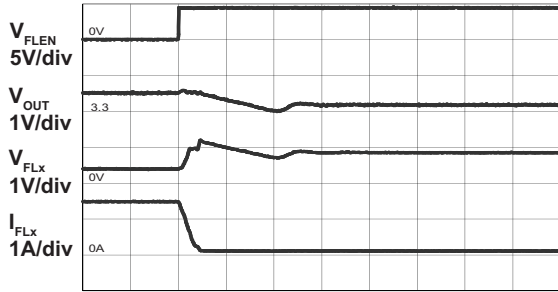

Time (100us/div)

Flash Mode Timing

($I_{FLOUTA} = I_{FLOUTB} = 750\text{mA}$; $C_{OUT} = 2.2\mu\text{F}$; $V_{IN} = 3.6\text{V}$; $L = 1\mu\text{H}$)

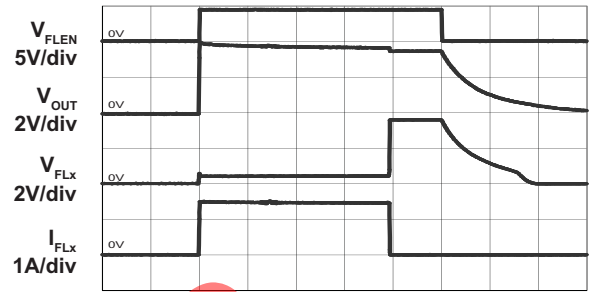

Time (100ms/div)

Movie Mode Ripple

($I_{FLOUTA} = I_{FLOUTB} = 50\text{mA}$; $C_{OUT} = 2.2\mu\text{F}$; $V_{IN} = 3.1\text{V}$; $L = 1\mu\text{H}$)

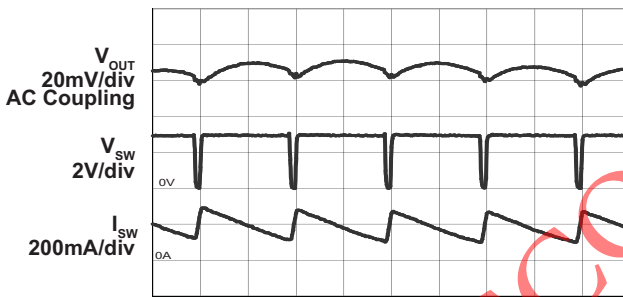

Time (500ns/div)

MEN, FLEN, FLINH Logic Threshold High vs Input Voltage

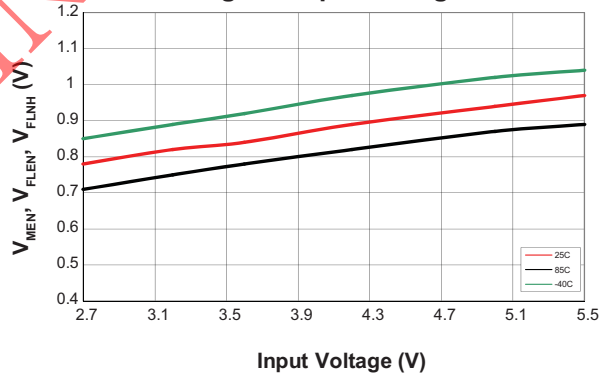

MEN, FLEN, FLINH Logic Threshold Low vs Input Voltage

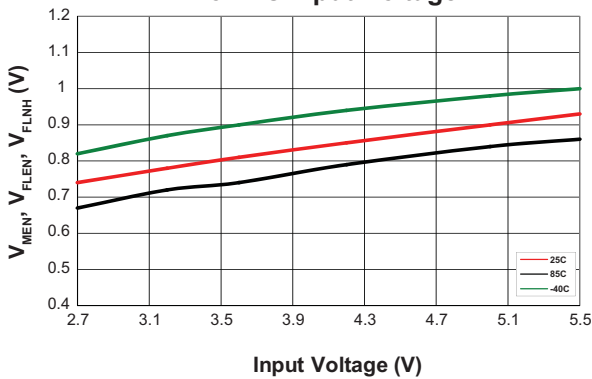

MEN, FLEN, FLINH Input Pull Down Resistance vs Temperature

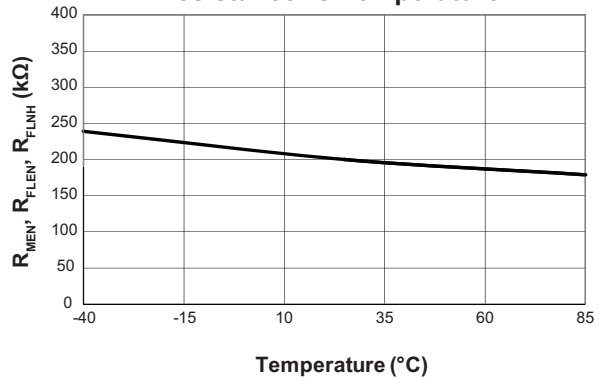

DISCONTINUED

1.5A Step-Up Current Regulator for Flash LEDs

Functional Block Diagram

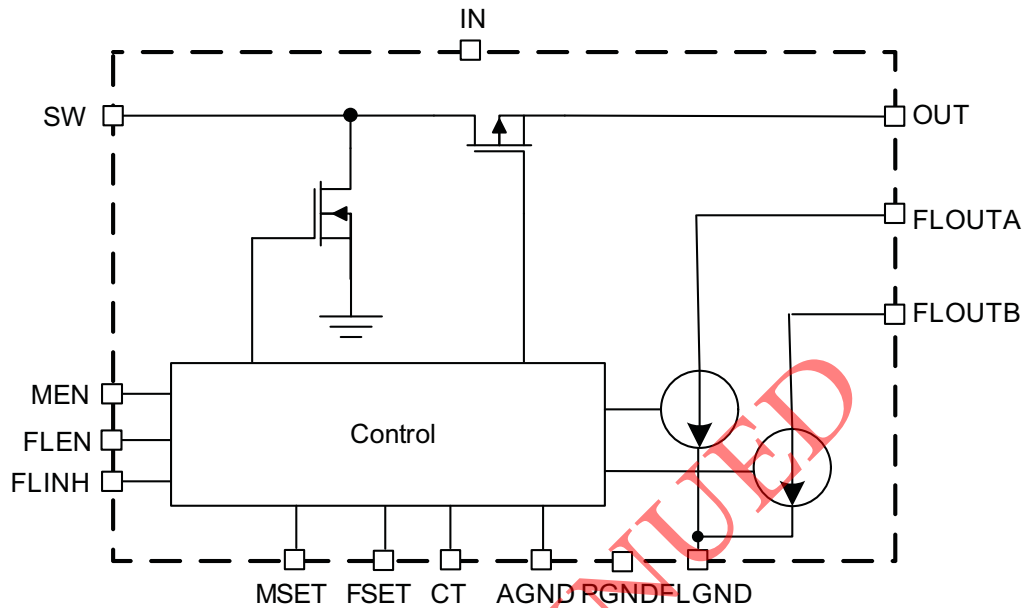

Functional Description

The AAT1277 is a boost converter with a current regulated output designed to drive high current white LEDs used in camera flash applications. The AAT1277 has two channels to accurately regulate the current flow through two separate white LEDs. There are two basic modes of operation in the AAT1277; a Flash mode controlled by the FLEN pin and movie mode controlled through the MEN pin.

Flash Mode

By strobing the FLEN input pin low-to-high, a flash pulse and the internal timer are initiated. The maximum flash current in the AAT1277 is set by an external resistor, R_{FSET} . The flash timer will terminate the flash current regardless of the status of the FLEN pin. This can be either used as a simple flash timing pulse or can be used as a safety timer in the event of a control logic malfunction to prevent the LED from overheating.

The maximum flash time is determined by an external timing capacitor connected to the CT pin. It is not recommended for the flash duration to be set longer than 1s.

If the safety timer is not needed in the application, it can be disabled by connecting the CT pin directly to AGND. After a flash event has expired via the flash timer, both

MEN and FLEN must be cycled to a logic low state to reset the flash timer.

The AAT1277 has two LED current sources which share the output current equally. For a single white LED application, the two current sources can be connected together to apply full output current into the LED. In two LED applications, each diode can be connected to its corresponding current source (FLOUTA or FLOUTB) and the output current will be shared. In applications where only one LED is connected to either FLOUTA or FLOUTB, the unused current sink must be directly connected to OUT, thereby disabling that channel.

Flash Inhibit Function

In mobile GSM systems where the phone remains in constant contact with the base station by regular communication, a FLINH pin is provided to prevent both the camera flash and PA transmission pulses from occurring simultaneously. This avoids potential dips to the Li-ion battery voltage below the system's undervoltage lockout threshold (UVLO). During a flash event, strobing the FLINH pin low-to-high reduces the LED current to the default movie-mode current level for the duration of FLINH. Strobing FLINH high-to-low instructs the AAT1277 to revert the flash LED current to its maximum level, assuming that the FLEN pin is still active (HIGH) and the flash timer has not expired.

1.5A Step-Up Current Regulator for Flash LEDs

Movie Mode

The movie mode is enabled when the MEN input pin transitions from low to high and will remain on until input is pulled back to a low logic level. The movie-mode current level is set by an external resistor connected between MSET and AGND. Channel current outputs (FLOUTA and FLOUTB) in movie mode operate in the same manner as they do in flash mode, only at a current level as set by the R_{MSET} resistor. The flash timer function is disabled in movie mode to permit constant LED illumination. The FLEN signal takes priority over movie-mode operation.

Over-Temperature Protection

Thermal protection disables the AAT1277 when internal power dissipation becomes excessive when operating. The junction over-temperature threshold is 140°C with 15°C of temperature hysteresis. The output voltage automatically recovers when the over-temperature fault condition is removed.

Over-Voltage Protection (Open LED, Open Circuit)

The AAT1277's output voltage is limited by internal over-voltage protection (OVP) circuitry, which prevents damage to the AAT1277 from open LED or open circuit conditions. During an open circuit, the output voltage rises and reaches 5.5V (typical), and the OVP circuit disables the switching, preventing the output voltage from rising higher. Once the open circuit condition is removed, switching will resume and the controller will return to normal operation.

Auto-Disable Feature

The AAT1277 is equipped with an auto-disable feature for each LED channel. After the IC is enabled and started up, a test current of 1mA (typical) is forced through each sink channel. The channel will be disabled if the voltage of that particular sink pin does not drop to a certain threshold. This feature is very convenient for disabling an unused channel or during an LED fail-short event. This small test current should be added to the set output current in both flash and movie mode conditions.

Timing Diagrams

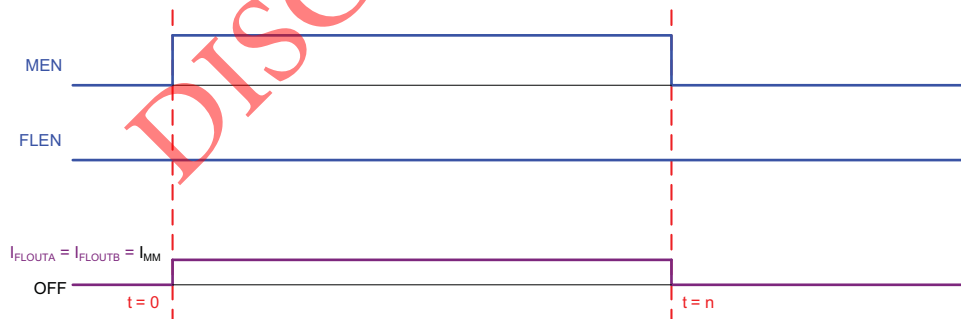

Figure 1: Movie Mode Timing Diagram.

1.5A Step-Up Current Regulator for Flash LEDs

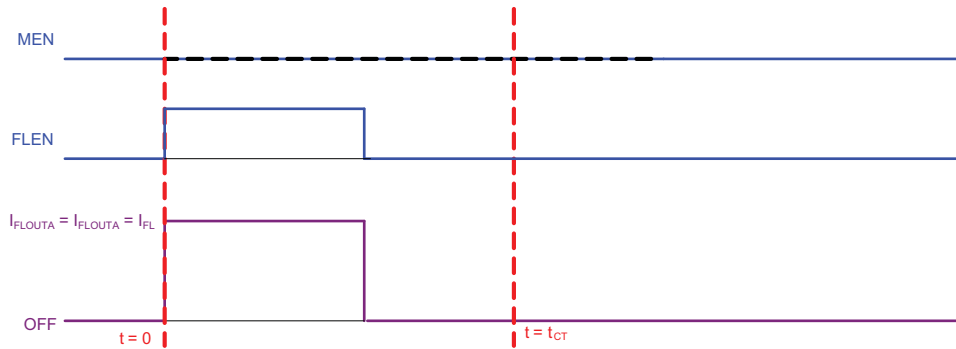

Figure 2: Diagram of Flash Mode When Flash Event Does Not Exceed Flash Timer $T_{FLASH} < T_{CT}$.

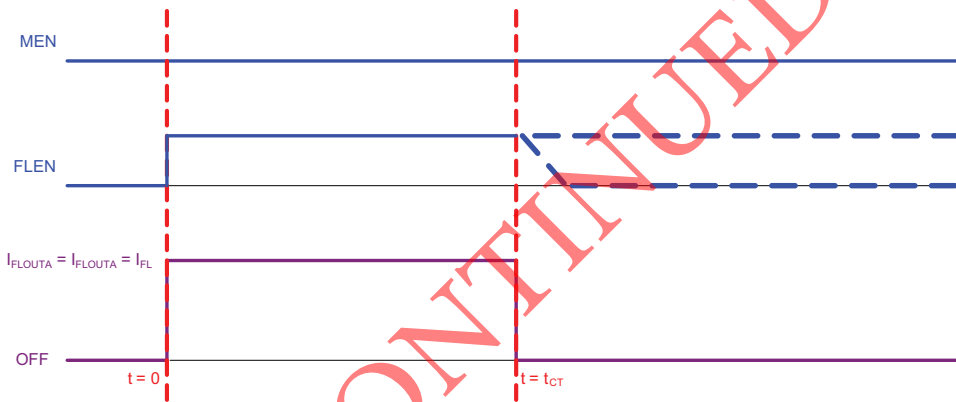

Figure 3: Diagram of Flash Mode Timing When Flash Event is Terminated by Flash Timer $T_{FLASH} \geq T_{CT}$.

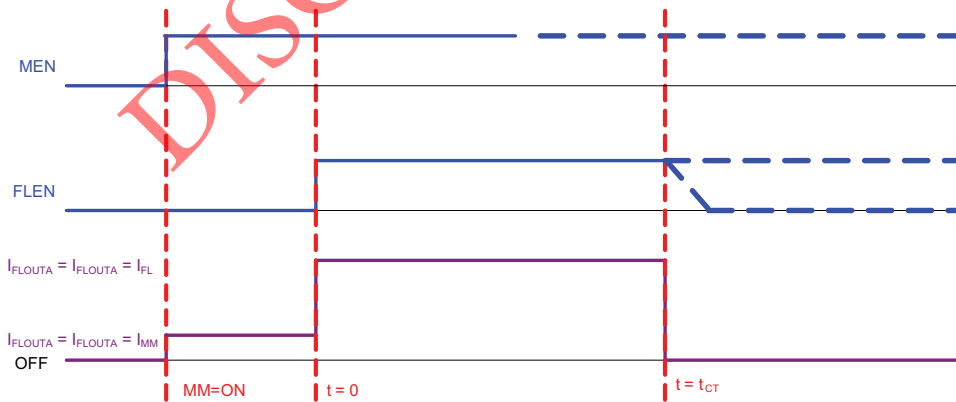

Figure 4: Diagram of Movie Mode Followed by Flash Mode When Flash Event is Terminated Before Flash Timer $T_{FLASH} < T_{CT}$ ^{1,2}.

1. FLEN must be pulled low after a flash time out period to reset the flash timer.
 2. Movie mode will not re-enable until FLEN returns low after flash time.

1.5A Step-Up Current Regulator for Flash LEDs

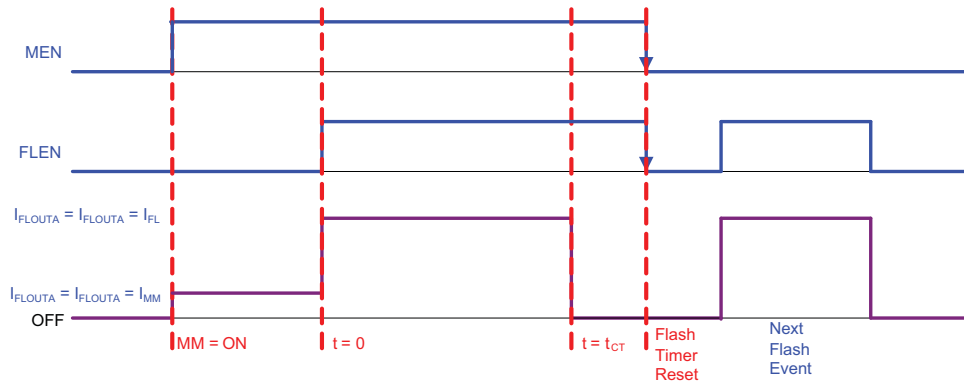

Figure 5: Diagram of Movie Mode Followed by Flash Mode When Flash Event is Terminated by Flash Timer $T_{FLASH} < T_{CT}$.

(Note: Both MEN and FLEN must return to a logic low state to reset the flash timer before the system can execute another flash or movie mode event.)

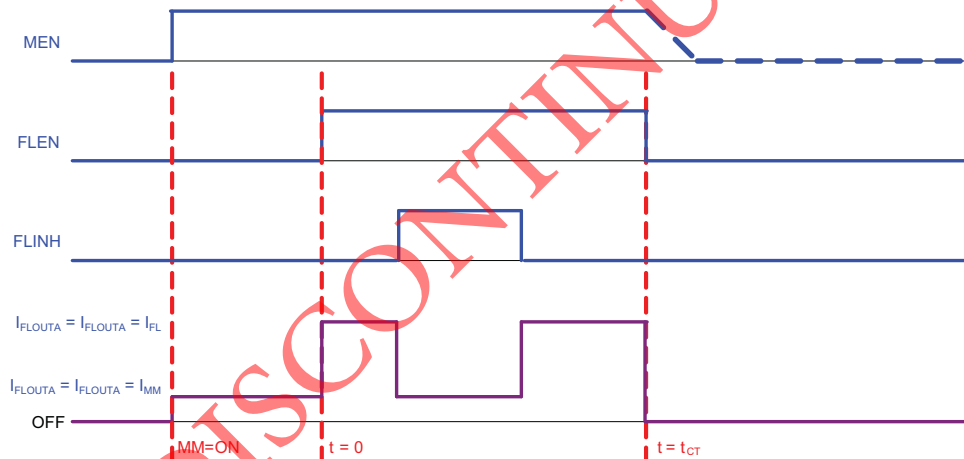

Figure 6: Diagram of Movie Mode Followed By Flash Mode With Flash Inhibit During Flash Event $T_{FLASH} < T_{CT}$.

(Note: The flash current is reduced to the movie mode current for the duration of FLINH).

1.5A Step-Up Current Regulator for Flash LEDs

Applications Information

LED Selection

The AAT1277 is specifically designed to drive white flash LEDs (typical forward voltage of 2.5V to 4.0V). Since the FLOUTA and FLOUTB input current sinks are matched with low voltage dependence; the LED-to-LED brightness will be matched regardless of the individual LED forward voltage (V_f) levels.

Flash Mode Current

FLOUTA and FLOUTB can be programmed up to a maximum total flash current of 1.5A or up to 750mA per channel. The output currents in FLOUTA and FLOUTB are equal.

The maximum flash current in each FLOUTA and FLOUTB is set by the R_{FSET} resistor. For the desired flash current in each output, the resistor value can be calculated using the following equation:

$$R_{FSET} = \frac{56.2k\Omega \cdot 750mA}{I_{FLOUTX}}$$

A flash event is initiated by asserting the FLEN pin. A flash event is automatically terminated when FLEN is de-asserted or if the safety timer terminates before the FLEN pin is de-asserted. Any time that the FLINH pin is asserted, the default movie-mode current level will appear at both FLOUTA and FLOUTB. The default movie-mode current level will be maintained on FLOUTA and FLOUTB as long as the FLINH and FLEN pins are asserted, and the safety timer continues to run.

Movie Mode Current

The AAT1277 movie mode current settings can be programmed by the external resistor R_{MSET} .

$$R_{MSET} = \frac{169k\Omega \cdot 50mA}{I_{MMOUTX}}$$

Flash Timer

The AAT1277 flash timer function is programmed by an external timing capacitor, C_T . The primary purpose of the flash timer is a safety function to prevent damage to the flash LED should a system error occur during a flash

event and fail to pull the FLEN input low after a flash event. The flash timer may also be used to strobe the flash relay in the timer to turn the flash off after a preset time determined by the C_T capacitor. This feature eliminates the need for an external housekeeping baseband controller to contain a safety or delay routine.

The flash time T can be calculated by the following equation:

$$T = 7.98s/\mu F \cdot C_T (\mu F)$$

Where T is in seconds and C_T is in μF .

For example, using a 47nF capacitor at C_T sets the flash timeout to:

$$\text{Flash Timeout} = 7.98s/\mu F \cdot 47nF = 375ms$$

The relationship between the flash safety timeout and the capacitance of the timer capacitor is illustrated in Figure 7.

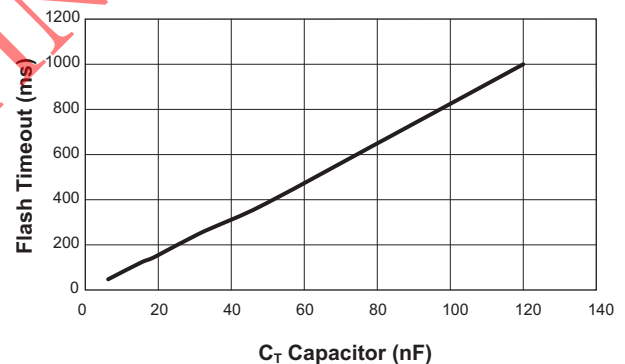

Figure 7: Flash Safety Timeout vs. Timer Capacitor.

Shutdown

The current sink devices (FLOUTA and FLOUTB) are the power returns for all loads, there is no leakage current through load if the current sink devices are disabled. When FLEN and MEN are both held at logic low level, the AAT1277 is disabled and draws less than 1uA of leakage current from VIN.

1.5A Step-Up Current Regulator for Flash LEDs

Selecting the Boost Inductor

The AAT1277 controller utilizes PWM control and the switching frequency is fixed. To maintain 2MHz maximum switching frequency and stable operation, a 1 μ H inductor is recommended. Manufacturer's specifications list both the inductor DC current rating, which is a thermal limitation, and peak inductor current rating, which is determined by the saturation characteristics. Measurements at full load and high ambient temperature should be performed to ensure that the inductor does not saturate or exhibit excessive temperature rise.

The inductor (L) is selected to avoid saturation at minimum input voltage and maximum output load conditions. Worst-case peak current occurs at minimum input voltage (maximum duty cycle) and maximum load. Bench measurements are recommended to confirm actual I_{PEAK} and to ensure that the inductor does not saturate at maximum LED current and minimum input supply voltage. The RMS current flowing through the boost inductor is equal to the DC plus AC ripple components. Under worst case RMS conditions, the current waveform is critically continuous. The resulting RMS calculation yields worst case inductor loss. The RMS current value should be compared against the inductor manufacturer's temperature rise, or thermal derating guidelines:

$$I_{RMS} = \frac{I_{PEAK}}{\sqrt{3}}$$

For a given inductor type, smaller inductor size leads to an increase in DCR winding resistance and, in most cases, increased thermal impedance. Winding resistance degrades boost converter efficiency and increases the inductor's operating temperature:

$$P_{LOSS(INDUCTOR)} = I_{RMS}^2 \cdot DCR$$

Selecting the Boost Capacitors

In general, it is good design practice to place a decoupling capacitor (input capacitor) between the IN and GND pins. An input capacitor in the range of 2.2 μ F to 10 μ F is recommended. A larger input capacitor in this application may be required for stability, transient response, and/or ripple performance. The high output ripple inherent in the boost converter necessitates the use of low impedance output filtering. Multi-layer ceramic (MLC) capacitors provide small size and adequate capacitance, low parasitic equivalent series resistance (ESR) and equivalent series inductance (ESL), and are well suited for use with the AAT1277 boost regulator. MLC capacitors of type X7R or X5R are

recommended to ensure good capacitance stability over the full operating temperature range. The output capacitor is selected to maintain the output load without significant voltage droop (ΔV_{OUT}) during the power switch ON interval. A 1 μ F ceramic output capacitor is recommended (see Table 2). Typically, 6.3V or 10V rated capacitors are required for this flash LED boost output. Ceramic capacitors selected as small as 0603 are available which meet these requirements. MLC capacitors exhibit significant capacitance reduction with applied voltage. Output ripple measurements should confirm that output voltage drop and operating stability are within acceptable limits. Voltage derating can minimize this factor, but results may vary with package size and among specific manufacturers. To maintain stable operation at full load, the output capacitor should be selected to maintain ΔV_{OUT} between 100mV and 200mV. The boost converter input current flows during both ON and OFF switching intervals. The input ripple current is less than the output ripple and, as a result, less input capacitance is required.

PCB Layout Guidelines

Boost converter performance can be adversely affected by poor layout. Possible impact includes high input and output voltage ripple, poor EMI performance, and reduced operating efficiency. Every attempt should be made to optimize the layout in order to minimize parasitic PCB effects (stray resistance, capacitance, and inductance) and EMI coupling from the high frequency SW node. A suggested PCB layout for the AAT1277 1.5A step-up regulator is shown in Figures 4 and 5. The following PCB layout guidelines should be considered:

1. Minimize the distance from capacitor C_{IN} and C_{OUT} 's negative terminals to the PGND pins. This is especially true with output capacitor C_{OUT} , which conducts high ripple current from the output to the PGND pins.
2. Minimize the distance under the inductor between IN and switching pin SW; minimize the size of the PCB area connected to the SW pin.
3. Maintain a ground plane and connect to the IC PGND pin(s) as well as the PGND connections of C_{IN} and C_{OUT} .
4. Consider additional PCB exposed area for the flash LEDs to maximize heatsinking capability. This may be necessary when using high current application and long flash duration application.
5. Connect the exposed paddle (bottom of the die) to either PGND or GND. Connect AGND, FLGND to GND as close as possible to the package.

1.5A Step-Up Current Regulator for Flash LEDs

| Manufacturer | Part Number | Inductance (µH) | Saturated Rated Current (A) | DCR (mΩ) | Size (mm) LxWxH | Type |
|-----------------|----------------|-----------------|-----------------------------|----------|-----------------|--------------------|
| Cooper Bussmann | SD3812-1R0-R | 1 | 2.69 | 48 | 4.0x4.0x1.2 | Shielded Drum Core |
| Cooper Bussmann | SDH3812-1R0-R | 1 | 3 | 45 | 3.8x3.8x1.2 | Shielded Drum Core |
| Cooper Bussmann | SD10-1R0-R | 1 | 2.25 | 44.8 | 5.2x5.2x1.0 | Shielded Drum Core |
| Sumida | CDH38D11/S | 1 | 2.8 | 48.8 | 4.0x4.0x1.2 | Shielded Drum Core |
| Coilcraft | LPS4012-102NLC | 1 | 2.5 | 60 | 4.1x4.1x1.2 | Shielded Drum Core |

Table 1: Typical Suggested Surface Mount Inductors.

| Manufacturer | Part Number | Capacitance (µF) | Voltage Rating (V) | Temp Co. | Case Size |
|--------------|-------------------|------------------|--------------------|----------|-----------|
| Murata | GRM185R60J225KE26 | 2.2 | 6.3 | X5R | 0603 |
| | GRM188R71A225KE15 | 2.2 | 10 | X7R | 0603 |
| | GRM21BR70J225KA01 | 2.2 | 6.3 | X7R | 0805 |
| | GRM21BR71A225KA01 | 2.2 | 10 | X7R | 0805 |
| | GRM219R61A475KE19 | 4.7 | 10 | X5R | 0805 |
| | GRM21BR71A106KE51 | 10 | 10 | X7R | 0805 |

Table 2: Typical Suggested Surface Mount Capacitors.

DISCONTINUED

*Denotes the default value.

AAT1277

1.5A Step-Up Current Regulator for Flash LEDs

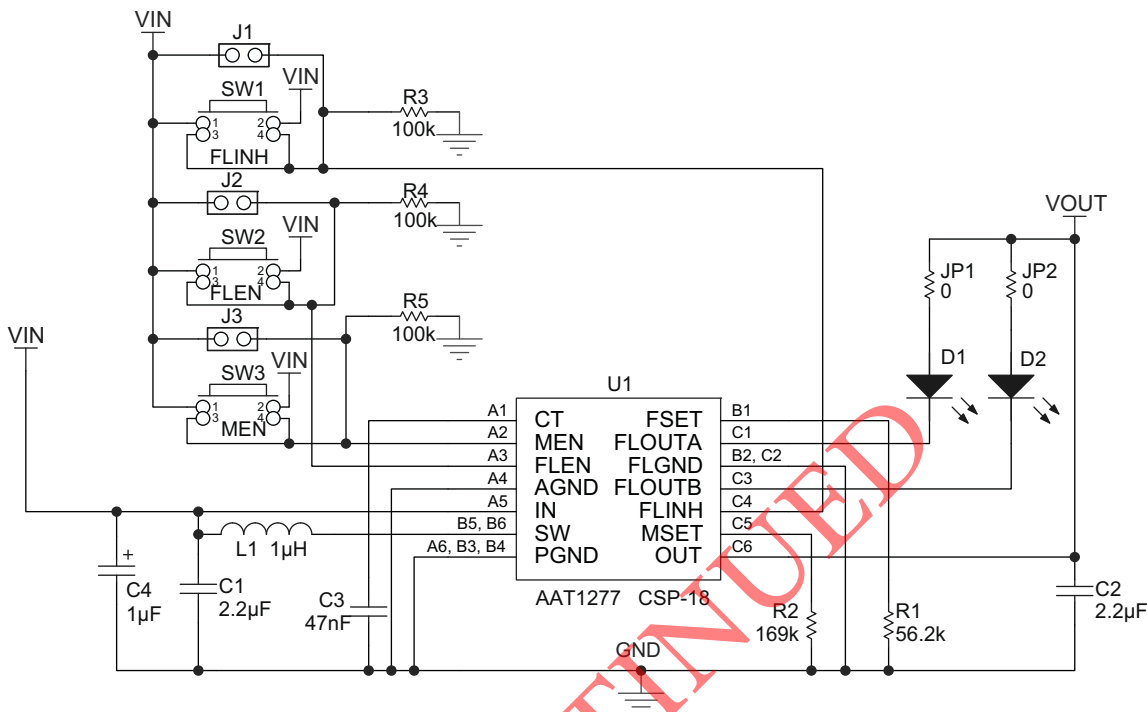

- D1, D2 Seoul Semi FOW401-Z4S
- L1 Cooper Bussmann SD3812-1R0-R, 1µH, 2.69A, 48mΩ
- C1, C2 Murata GRM188R71A225KE15 2.2µF, 0603, X7R, 10V
- C3 Murata GRM155R71A473KA01, 47nH, 0402, X7R, 10V

Figure 8: AAT1277 Evaluation Board Schematic.

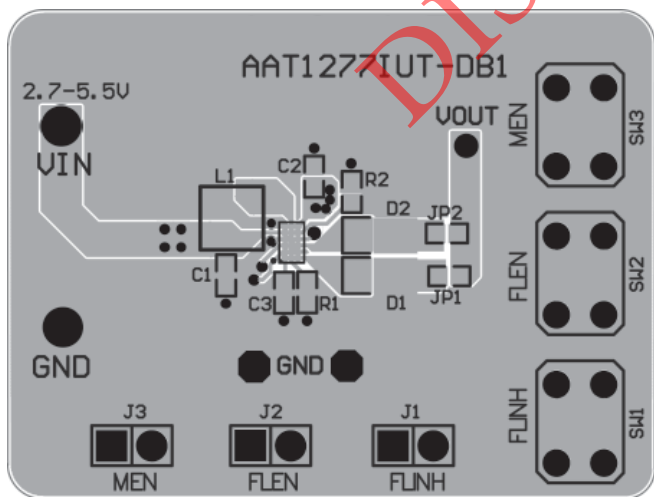

Figure 9: AAT1277 Evaluation Board Top Side Layout.

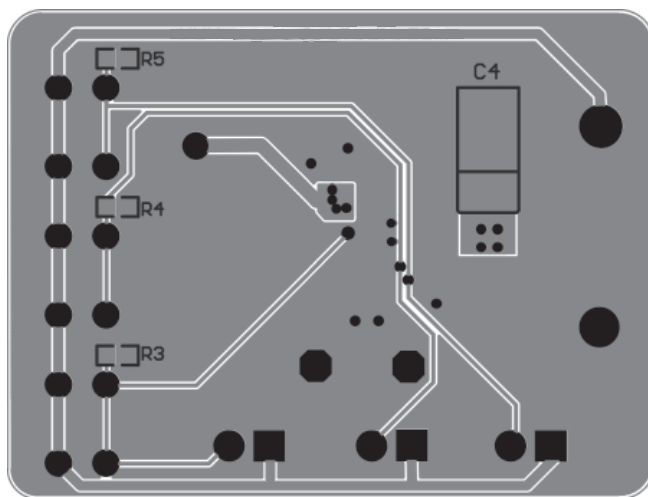

Figure 10: AAT1277 Evaluation Board Bottom Side Layout.

1.5A Step-Up Current Regulator for Flash LEDs

| Component | Part Number | Description | Manufacturer |
|------------|-------------------|---|-------------------|
| U1 | AAT1277IUT | 1.5A Step-Up Current Regulator for Flash LEDs; 18 ball 1.5mm x 2.4mm CSP package | Skyworks |
| SW1 – SW3 | PTS645TL50 | Switch, SPST, 5mm | ITT Industries |
| R1 | Chip Resistor | 56.2k Ω , 1%, 1/4W; 0402 | Vishay |
| R2 | Chip Resistor | 169k Ω , 1%, 1/4W; 0402 | Vishay |
| R3, R4, R5 | Chip Resistor | 100k Ω , 1%, 1/4W; 0603 | Vishay |
| JP1, JP2 | Chip Resistor | 0 Ω , 5%, 1/4W; 0603 | Vishay |
| C1, C2 | GRM188R71A225KE15 | 2.2 μ F, 10V, X7R, 0603 | Murata |
| C3 | GRM155R71A473KA01 | 47nF, 10V, X7R, 0402 | Murata |
| L1 | SD3812-1R0-R | Drum Core, 1 μ H, 2.69A, 48m Ω | Cooper Bussmann |
| D1-D2 | LXCL-PWF4 | White Flash LED | Lumileds, Philips |

Table 3: AAT1277 Evaluation Board Bill of Materials.**DISCONTINUED**

DATA SHEET

AAT1277

1.5A Step-Up Current Regulator for Flash LEDs

Ordering Information

| Package | Marking ¹ | Part Number (Tape and Reel) ² |
|---------|----------------------|--|
| CSP-18 | M6XYY | AAT1277IUT-T1 |



Skyworks Green™ products are compliant with all applicable legislation and are halogen-free. For additional information, refer to *Skyworks Definition of Green™*, document number SQ04-0074.

Package Information

CSP-18

Dimension Table (Unit: mm)

| Symbol | Min | Nominal | Max |
|--------|------------|---------|-------|
| A | 0.535 | 0.620 | 0.705 |
| A1 | 0.145 | 0.170 | 0.195 |
| A2 | 0.355 | 0.380 | 0.405 |
| A3 | 0.035 | 0.070 | 0.105 |
| D | 2.375 | 2.410 | 2.445 |
| E | 1.495 | 1.530 | 1.565 |
| D1 | 2.000 BSC | | |
| E1 | 0.800 BSC | | |
| e | 0.400 BSC | | |
| b | 0.180 | 0.205 | 0.230 |
| X | 0.30 | - | - |
| Y | 0.30 | - | - |
| X1 | - | 0.1 | - |
| Y1 | - | 0.1 | - |
| N | 18 (Balls) | | |

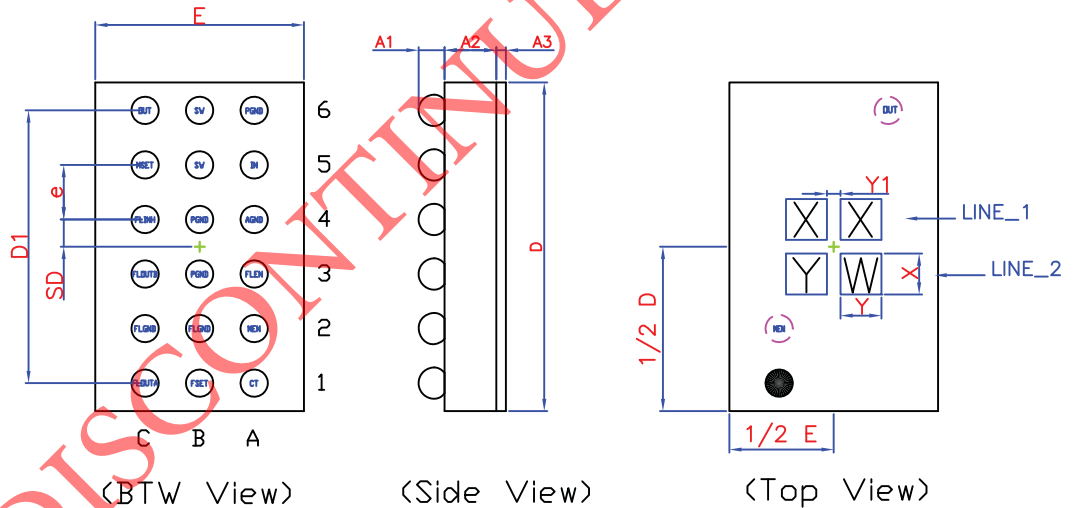

| Device Name | Marking Code |
|---------------|--------------|
| AAT1277IUT-T1 | |
| | |
| | |

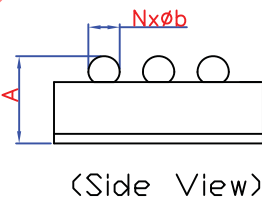

All dimensions in millimeters.

1. XYY = assembly and date code.
 2. Sample stock is generally held on part numbers listed in **BOLD**.
 3. The leadless package family, which includes QFN, TQFN, DFN, TDFN, and STDFN, has exposed copper (unplated) at the end of the lead terminals due to the manufacturing process. A solder fillet at the exposed copper edge cannot be guaranteed and is not required to ensure a proper bottom solder connection.

1.5A Step-Up Current Regulator for Flash LEDs

DISCONTINUED

Copyright © 2012 Skyworks Solutions, Inc. All Rights Reserved.

Information in this document is provided in connection with Skyworks Solutions, Inc. ("Skyworks") products or services. These materials, including the information contained herein, are provided by Skyworks as a service to its customers and may be used for informational purposes only by the customer. Skyworks assumes no responsibility for errors or omissions in these materials or the information contained herein. Skyworks may change its documentation, products, services, specifications or product descriptions at any time, without notice. Skyworks makes no commitment to update the materials or information and shall have no responsibility whatsoever for conflicts, incompatibilities, or other difficulties arising from any future changes.

No license, whether express, implied, by estoppel or otherwise, is granted to any intellectual property rights by this document. Skyworks assumes no liability for any materials, products or information provided hereunder, including the sale, distribution, reproduction or use of Skyworks products, information or materials, except as may be provided in Skyworks Terms and Conditions of Sale.

THE MATERIALS, PRODUCTS AND INFORMATION ARE PROVIDED "AS IS" WITHOUT WARRANTY OF ANY KIND, WHETHER EXPRESS, IMPLIED, STATUTORY, OR OTHERWISE, INCLUDING FITNESS FOR A PARTICULAR PURPOSE OR USE, MERCHANTABILITY, PERFORMANCE, QUALITY OR NON-INFRINGEMENT OF ANY INTELLECTUAL PROPERTY RIGHT; ALL SUCH WARRANTIES ARE HEREBY EXPRESSLY DISCLAIMED. SKYWORKS DOES NOT WARRANT THE ACCURACY OR COMPLETENESS OF THE INFORMATION, TEXT, GRAPHICS OR OTHER ITEMS CONTAINED WITHIN THESE MATERIALS. SKYWORKS SHALL NOT BE LIABLE FOR ANY DAMAGES, INCLUDING BUT NOT LIMITED TO ANY SPECIAL, INDIRECT, INCIDENTAL, STATUTORY, OR CONSEQUENTIAL DAMAGES, INCLUDING WITHOUT LIMITATION, LOST REVENUES OR LOST PROFITS THAT MAY RESULT FROM THE USE OF THE MATERIALS OR INFORMATION, WHETHER OR NOT THE RECIPIENT OF MATERIALS HAS BEEN ADVISED OF THE POSSIBILITY OF SUCH DAMAGE.

Skyworks products are not intended for use in medical, lifesaving or life-sustaining applications, or other equipment in which the failure of the Skyworks products could lead to personal injury, death, physical or environmental damage. Skyworks customers using or selling Skyworks products for use in such applications do so at their own risk and agree to fully indemnify Skyworks for any damages resulting from such improper use or sale.

Customers are responsible for their products and applications using Skyworks products, which may deviate from published specifications as a result of design defects, errors, or operation of products outside of published parameters or design specifications. Customers should include design and operating safeguards to minimize these and other risks. Skyworks assumes no liability for applications assistance, customer product design, or damage to any equipment resulting from the use of Skyworks products outside of stated published specifications or parameters.

Skyworks, the Skyworks symbol, and "Breakthrough Simplicity" are trademarks or registered trademarks of Skyworks Solutions, Inc., in the United States and other countries. Third-party brands and names are for identification purposes only, and are the property of their respective owners. Additional information, including relevant terms and conditions, posted at www.skyworksinc.com, are incorporated by reference.